

Designing for heart rate and breathing movements

Abstract

In this article we summarize a number of facts and design challenges related to the movements of our heart and how it interacts with breathing and stress. We take a design perspective, being interested in creating bio-feedback systems which empower their users in matters of health and coping with stress. Taking a design perspective also means trying to understand the working of the full loop which includes both the user and the bio-feedback device(s). The form-giving of the feedback to the user is an important design issue, which is still largely unexplored. We show some of our explorations, including a new representation called circle maps, based on Poincaré plots. Their usage for real-time feedback is new to the best of our knowledge.

Keywords

Feedback Design, Bio-Feedback, Heart Rate, Variability, Stress, Autonomic Nervous System, Visualization, Experience Design

I Introduction

In the context of design and movement, some of the most interesting and vital movements are generated by the dynamic systems inside ourselves. In this article we contribute to exploring the design space of making some of these movements accessible to our conscious mind in ways which are beneficial to the user him or herself. In an earlier work we gave an overview of the

entire field of bio-feedback from a gaming perspective [1]. Now we look closer to one of the design aspects, namely presentation and form-giving of feedback to the user. The paradigm of bio-feedback emerges in the domains of relaxation, gaming, psychotherapy, and diagnosis. Whereas the relaxation and gaming applications are designed with attention for the aesthetics of the interaction, applications of psychotherapy and diagnosis are driven by medical needs and technical opportunities. It is interesting from a semantic point of view that bio-signals have meanings which are not so obvious (for example, high heart rate variability means relaxation). Moreover, any designed representation may carry additional messages.

Important benefits of perceived stress reduction, self-awareness and self-control are in essence experiential (although formal experiments can turn them objective again). Nevertheless, for the present work, which we like to report to the DeSForM community, we try to make use of understandings gained through medical science, engineering and design exploration to create beneficial experiences. The article is structured as follows. Section 2 is about the heart: we explain what heart rate variability is and why it matters. Section 3 is about breathing and its interaction with heart rate. Sections 4 and 5 chart the design opportunities and challenges. Sections 6 and 7 report on our own explorations. Finally Section 8 looks ahead.

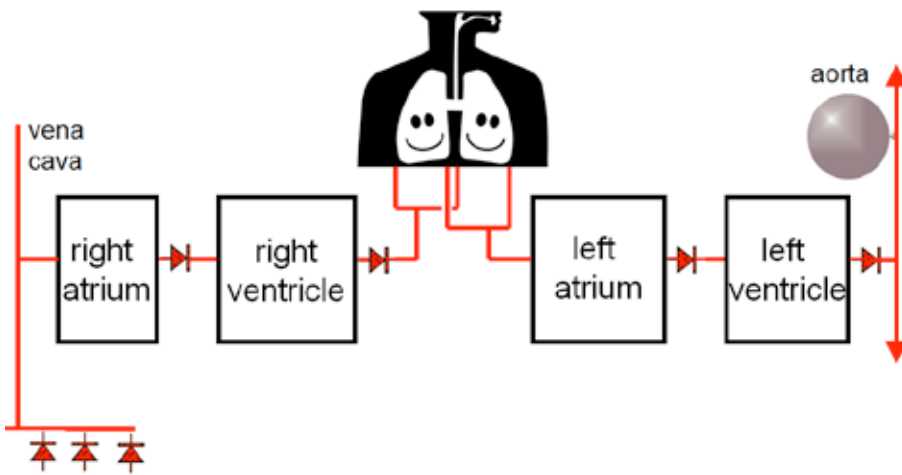

Fig. 1. Schematic diagram of the heart and its role in blood flow. The balloon at the right is a symbolic representation for the elastic buffer capacity of the big arterial vessels. The two atriums contract first, followed by the ventricles.

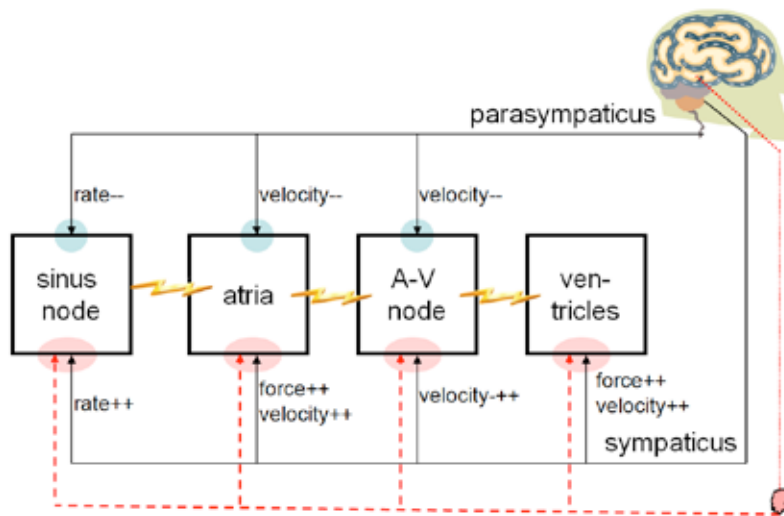

Fig. 2. Schematic diagram of the heart and some of the most important hormonal and nervous signals affecting the rate, force and velocity of the contractions [3]. The notation rate++ means that the rate goes up whereas rate-- denotes a signal which causes the heart rate to decrease. Both the sympathetic and the parasympathetic belong to the autonomic nervous system. The dotted line stands for the hormonal signals, notably adrenaline.

2 How the heart beat is regulated

The heart is one of our main vital organs. It is associated with the emotional aspects of life, because the heart needs to adapt continuously to all kinds of changes in the environment. An important function is to pump the blood through the body, as shown in Fig. 1.

The heart works as an autonomic oscillator. In other words, there is no such thing as a command “contract now” coming from the brain to the heart. But the autonomic nervous system controls the activity of the heart indirectly through a number of pathways, as sketched in Fig. 2.

Next to hormones, such as adrenalin (epinephrine), there are two nerve-based pathways. The first is the sympathetic branch of the autonomic nervous system (sympathicus), which has the effect of increasing heart rate and force of the heart beats. The second is the parasympathetic branch of the autonomic nervous system (parasympathicus), which acts as a kind of brake. Normally both branches are active simultaneously and form an equilibrium (which is okay, unlike driving a car,

where it is a bad idea to apply the gas throttle and the brake simultaneously).

These pathways are part of a feedback control system, the main function of which is to adjust the blood flow to the needs and the anticipated needs of the body while keeping the blood pressure within safe limits. In the field of physiology this concept is known as homeostasis: keeping physiological systems constant, or at least within bounds. Examples of important physiological systems that are kept constant are body temperature (37° C), salt level (0.9% NaCl), sugar level (0.1% glucose), and blood volume (5-6 liters). The body has an extensive networks of sensors and effectors to maintain homeostasis.

The main feedback control loop for heart rate is summarized in Fig. 3. If the sensors indicate that the blood pressure is becoming too high, the heart slows down (baroreflex). At the same time, flow is helped by variable-width veins opening up. If the sensors indicate that the blood pressure is becoming too low, the heart rate increases and the heart beats with more force. At the same time, the variable-width veins close somewhat, thus restricting the blood flow.

Fig. 3. Schematic diagram of the heart rate control loop. The pump is symbolic for the heart, the balloon for the elastic buffer capacity of the big arterial vessels, and the radiator for the variable-width veins that can be controlled to either pass or resist blood flow.

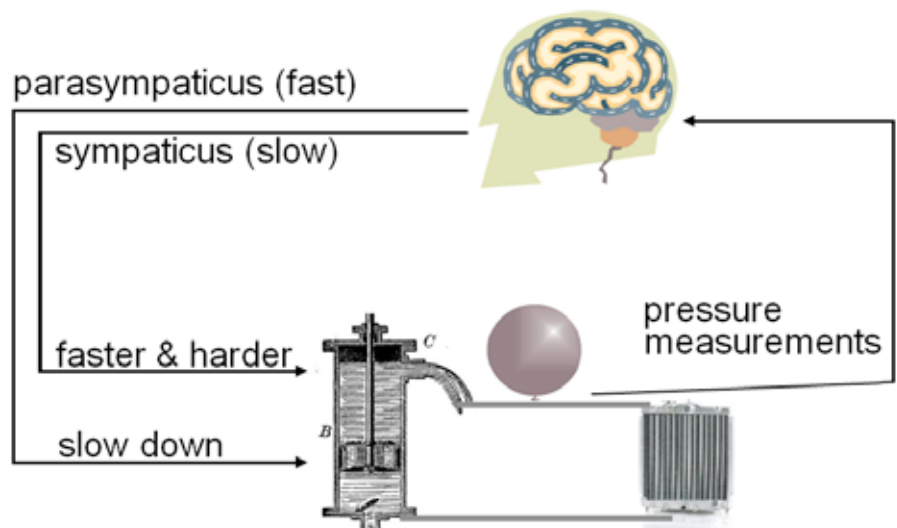

The heart rate control loop keeps the blood pressure within safe limits, in the same way in which a thermostat regulates the temperature in a room. If the room is too hot, the heating is switched off, and perhaps cooling is added. If the room is too cold, the heating goes on. What traditionally makes feedback control design challenging is the dynamics of the system's behavior. It makes no sense just to study the thermostat or the heater, nor does it make sense to have more and more accurate measurements of the room. It is their interaction in a system which determines whether the temperature will converge to a set point (and if so, how slow or how fast, and with how much overshoot), or whether the system will enter into an oscillation. The best-known oscillation caused by feedback is the sound when a microphone is in front of the loudspeaker connected to the same amplifier. But oscillations also occur in economies where producers and consumers react to markets in combination with delays and storage capacities. The system of Fig. 3 is such a feedback loop. Indeed, there are delays (for example the slow neurotransmitters of the sympaticus) and storage capacities (the elastic buffer capacity of the big arterial vessels). In practice, the heart rate is not completely stable (not even when the person is at rest), nor does it enter an unbounded oscillation.

The variation of heart rate is known as HRV (Heart Rate Variability). A non-zero HRV is a sign that the feedback loop is working. The statistics and the frequency components of HRV are studied intensively in the context of stress measurement. For certain types of patients, low HRV can be correlated with certain heart- and blood-vessel related disorders. The literature on HRV is huge, and the number of measures to indicate the degree of HRV is huge, if not bewildering. There are tools such as Kubios to calculate a wide variety of HRV measures [2].

An interesting phenomenon in the dynamics of HRV is that the system tends to have an eigen-frequency near 0.1 cycles per second. The precise value differs somewhat from person to person.

Another interesting phenomenon is that under conditions of stress, the HRV tends to be lower than under normal conditions when the person is relaxed. This can be explained by the fact that under stress the parasympatic brake function is so diminished, that it is not regulating anymore (note that this is the regulator with the fast neurotransmitters responsible for most of the fast dynamics). The mechanisms are by now fairly well understood, see for example DeBoer [3].

3 Breathing

Breathing is interesting because it can be done voluntarily, but if no attention is paid to it, an autonomic regulation will take over. Since ancient times, breathing has been studied and was used to develop methods and therapies empowering their users in matters of health and coping with stress. Without any claim of completeness we mention pranayama yoga, ānāpānasati meditation [4], and autogenic training [5]. Breathing influences the heart rate; an effect is called RSA (respiratory sinus arrhythmia). The medical term respiratory sinus arrhythmia sounds perhaps like a disease, but actually it is not, on the contrary, it is a sign of working feedback (homeostatis). When breathing in, the heart rate goes up, when breathing out, it goes down. Functionally, this link has ecological validity in that sympathetically controlled situations of activation (fight/flight) are associated with high heart rate AND breathing levels, whereas situations of parasympathetically controlled relaxation and vegetation are associated with low levels of heart rate AND breathing levels.

RSA can be deployed in a special breathing exercise called resonant breathing. It is based on the above-mentioned phenomenon in the dynamics of HRV that the heart control system resonates at a frequency near 0.1 cycles per second (the precise value differs somewhat from person to person). This is illustrated by the plot of an experiment done in our own bio-feedback laboratory, see Fig. 4. The user of our sensor was asked to breathe in a rhythm with a predetermined breathing frequency. Since the breath modulates the heart beat (RSA), the HRV tends to be highest when breathing at the person's eigen-frequency. For this person it was 0.1 Hertz, indeed.

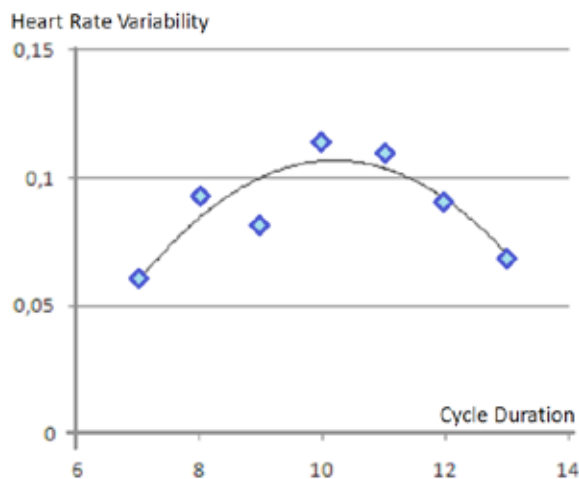

Fig. 4. Heart Rate Variability measured for various Cycle Duration times during 120 seconds for a healthy 36 year old male. Heart Rate Variability is given as the RR Triangular Index as calculated by Kubios. Cycle Duration is in seconds and was provided as feed-forward to the subject through the EZ-Air paced breathing program of BFE (Bio-Feedback Europe). The line is a 2nd order polygonal trend.

4 Design opportunities

It is possible to display HRV in some representation and provide this information to the user who may use it to train and gradually gain some voluntary control over his or her own HRV and possibly also his/her degree of relaxation. Usually this involves the usage of some special sensors, and a display which can be visual, auditory or even based on 3D movement. It can be combined with feed-forward and the measurement of other bodily signals such as EMG (electro-myogram), EEG (electro-encephalogram) or GSR (Galvanic skin conductivity). HRV can be derived from ECG

signals (electro-cardiogram) or PPG signals (photo plethysmography). HRV feedback has been reported to be helpful or probably helpful in a number of medical conditions, including asthma, fibromyalgia, depression and post-traumatic stress disorder [6, 7, 8, 9]. The development of the sensors is full of technical problems, but gradually they are becoming cheaper, smaller, more reliable, less obtrusive and more comfortable. We do not address the associated design issues here; it suffices to mention that in our lab and design studio we work with ECG (either adhesive or textile electrodes) and PPG (either at the ear lobe or at a finger).

Without claim for completeness, we give a short list of existing designs, which are commercially available devices and sensor/software combinations.

- Stress-eraser, a portable device, entirely based on pure HRV feedback, and bar-chart feedback on a small screen. The sensor is of the PPG type for one finger.
- Em wave, using a sensor to be connected to a regular PC and entirely based on HRV, usually taken with a PPG sensor. It offers a variety of graphical and chart-based feedback methods.
- Mind-surfer, using EEG signals with either graphical or audio feedback. To be used with traditional sensor head caps (we designed a special user-friendly alternative cap [10] but the design is not commercially available yet). The software runs on a regular PC.
- Journey to the Wild Divine is based on both HRV and GSR. It comes with special sensors with one PPG finger clip and two GSR clips. The software runs on a regular PC and includes beautiful scenery, Zen gardens, etc.

As a measure for HRV, most of these programs use the LF/HF ratio. [11] In this ratio, "LF" refers to the Low Frequency band around the 0.1 cycles per second as mentioned in section 3. This band is driven by both the parasympathetic and sympathetic loops of Fig. 2 and reflects the baroreceptor activity as mentioned in section 2. The High Frequency "HF" band is driven by respiration and appears to derive mainly from the parasympathetic loop from Fig. 2. This band is defined by variations between 0.04 and 0.15 cycles per second. So, the LF/HF ratio is a normalized merit in the frequency domain.

The design opportunities break down into the choice for an effective merit (in the time domain, frequency

domain or other), and the representation method. In the remainder of this paper we focus on these two aspects for HRV-based bio-feedback.

5 Feedback loop design challenges

Several fundamental questions concerning the feedback arise. A question already explored by Djajadiningrat [12] is whether the feedback display should be in the user's center of attention, or perhaps more in the background. The "Mirror of Emotion", as used in their study, puts them in the background; it is more a kind of warning system than a training tool that should be in the center of attention. In contrast, most devices designed for training purposes, assume that the user will focus on the feedback.

The designers of the Wild Divine clearly assumed that it would help for the sounds and the images to be beautiful and give associations with Eastern meditation techniques, Zen gardens, etc. Whether this is helpful indeed is still to be investigated. In theory, the images and sounds could be distracting from the task at hand. In fact, the notion of "task-at-hand" in itself is questionable too. There is a kind of paradoxical situation which arises whenever a relaxation or meditation goal is approached as a serious task to be fulfilled effectively and efficiently. When trying too hard, the task to relax becomes even harder or impossible. Another open question is the role of narrative. Going further, let us assume that the task at hand is relaxation. Then it is not obvious what that means: mental relaxation? Physical relaxation? High HRV? Fortunately there is a lot of evidence that mental relaxation and physical relaxation are not independent. For example, in PMR (progressive muscle relaxation) as developed by Jacobson the method is based on the idea that muscle relaxation can only occur when there is mental relaxation and therefore it makes sense to train muscle relaxation when the goal is also mental relaxation. Despite the vast literature on HRV it is hard to find how long one should train to get effects reliably. Another design dilemma is about the reward scheme. Does it make sense to offer rewards, bonuses etc. for successful training (increased HRV, for example), or is it better to rely on intrinsic motivation and intrinsic reward? Also the internal nervous pathways of the training are not clear: is it possible to get control over HRV directly, or does one get control over other correlates or causes of stress and is an increased HRV

a consequence of that? Yet another alternative is that one just explores and trains breathing patterns which are effective to increase HRV.

Last but not least, a very important design question is how to give the measured information back to the user. This is the question we shall focus on in the remainder of this paper. It is useful to distinguish two layers of design for the feedback.

- Surface level design: choice between sound, visual, 3D movement, or tactile feedback. What colors to use, which forms, which narrative elements, and so on.
- Structural design. Which information is coded in the representation and what is the timing of that information in relation to the mental and bodily processes in the feedback loop.

5.1 Surface level design

Regarding the surface level design, the Journey to the Wild Divine has made a specific choice, assuming that beautiful scenery and sounds will be helpful. Indeed, it is well possible, even plausible, that this beauty and the associations that come with the scenery and the sounds induce relaxation, even without bio-feedback. Also in the Mirror of Emotions by Djajadiningrat [12] the mirror had to be a beautifully design sphere with esthetically pleasing patterns.



Fig. 5. Scenery from the Journey to the Wild Divine. The design is rich, full of narrative elements and aesthetically pleasing.

In the design of the StressEraser, the choice seems more pragmatic and minimalistic. The device is portable, mono-functional and hence avoids the unrest which normally comes with PCs. The StressEraser has a bar-chart display, as shown in Fig. 6.



Fig. 6. StressEraser. The design is minimalistic, sober and resembles a laboratory instrument.

The difference may well be explained by background, whether the developers come from a medical, technical, laboratory environment or from an artistic, humanistic or studio environment, or on how much development budget was available. But in the end, it has to be approached as a design question which has to deliver both effectiveness and cultural value. In our design education program at TU/e, the topic of feedback design is considered an interesting vehicle for learning and we have seen students create feedback forms such as tactile vibration-motor feedback, 3D geometric installations, flowers, and arcade games.

5.2 Structural design

Next we address the structural design. We claim that there are fundamental choices to be made, almost orthogonal (independent) to the choice for surface design. We show two different alternatives, to which we shall add a third alternative, which is new to the best of our knowledge (in Section 6). The classical alternatives are:

1. Representation of calculated HRV;
2. Representation of successive beat-to-beat intervals.

To get started, consider the following scene from the Wild Divine, which is based on the first alternative (Fig. 7).

The feedback in the first classical approach (Representation of calculated HRV) works essentially as follows: the internal game software calculates the present value of the relaxation, some measure of HRV, either based on statistical or frequency based analysis, and possible combined with the GSR according to some formula for weighted average. This value (a number) is translated into the height of the feather, so when HRV increases (or skin conductivity decreases), the feather goes up. Other tasks in the Journey to the Wild Divine are coded similarly: there are stones to be lifted,



Fig. 7. Task inside the Wild Divine. Help the feather float up to the top of the screen. With your mind.

fires to go up, doors to be opened, and so on. But note that this principle does not rely on the Zen garden narrative. The same fits with other narratives: the bird has to fly higher, the fish has to avoid the surface. It can be done in a laboratory-instrument styling as well: the bar chart has to up. It can be done in 3D forms (the geometric dome has to grow) or with light (the light has to glow brighter, get greener, etc.). In addition, the scenery setting of the Journey to the Wild Divine, triggers curiosity that is rewarded by progress of the journey. This could be another feedback method, making use of the paradox of balancing excitement with relaxation.

The feedback in the second classical approach (representation of successive beat-to-beat intervals) works as follows. Each beat-to-beat or "RR" interval is represented individually so that the respiratory sinus arrhythmia becomes noticeable as a wave pattern in the resulting series of representations. This is precisely what the Stress-Eraser does. The principle is also shown in the screen-shot of our own Processing software program [13] in Fig. 8, where also added the technique to let the older beats gradually fade away. This graph is sometimes referred to as "tachogram"

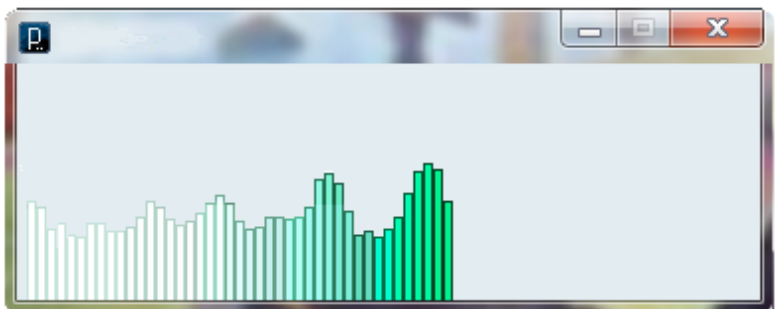

Fig. 8. Feedback by plotting successive beat-to-beat intervals.

During the forty-three heart beats shown in Fig. 8, the Heart Rate Variability is gradually increasing. The bar plots are built-up from left to right. The bar plot is showing waves of larger amplitude (the higher the bar, the longer the beat-to-beat interval).

6 Explorations

Focusing on the structural design aspects, we noted that the calculated HRV works on the basis of a slowly growing accumulative effect, whereas the presentation of successive beat-to-beat intervals is more direct. These two different merits, however, do contain different information aspects of the influence of the (para)sympathetic nervous system on the heart. For example, the 0.1 cycle per second signal as mentioned before, can only be recovered by measuring at least 10 heartbeats assuming the heart rate is 1 per second. So, the HRV merit from the frequency domain is intrinsically slow. On the other hand, the beat-to-beat plot includes high frequency information as the variation between two neighboring bars.

We asked whether it would be possible to go one step further, developing a presentation which is even more direct and accurate by focusing on the differences between successive beat-to-beat intervals rather than the intervals themselves. This turns out possible by adapting a way of data plotting which recently has become popular in the analysis of HRV [14], but which has not been applied for real-time-feedback, to the best of our knowledge. This is shown in Fig. 9. The notation RR_n means the n -th beat-to-beat interval whereas RR_{n+1} means the $(n+1)$ -th beat-to-beat interval. So after beat numbered n , the next interval is plotted on the y -axis and the previous interval on the x -axis. But for the next beat, the roles change: the value which was vertical is used for the x now whereas the next value, RR_{n+2} is plotted vertically. This way of presenting the behavior of a dynamic system is named after the Frenchman Jules Henri Poincaré (1854–1912) who studied complex dynamic systems and was one of the founders of modern chaos theory.

Compared to the traditional usage of Poincaré plots, in order to make them useful for feedback purposes, we have made three modifications. First, the plot is generated at real-time, not a posteriori. Secondly, we let the older dots fade away, so the image does not get cluttered up with too many irrelevant dots. Thirdly,

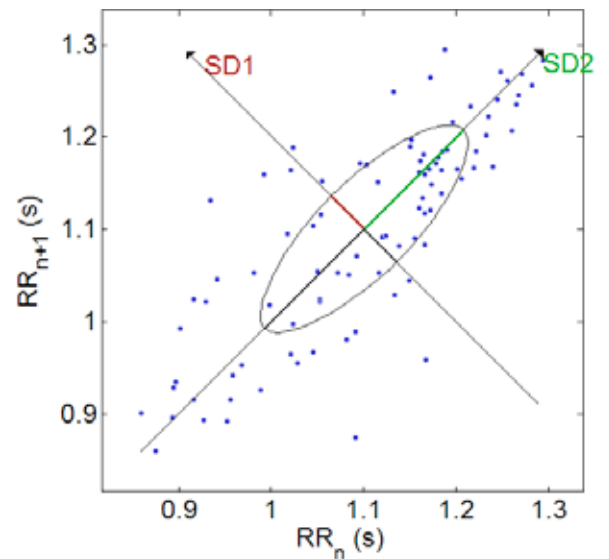

Fig. 9. Traditional usage of Poincaré Plot for off-line analysis of Heart Rate Variability. The graph is generated by Kubios Version 2.0. The RR interval (= beat to beat interval) is plotted vertically, against the previous RR interval, which defines the position on the horizontal axis.



Fig. 10. Circle plot obtained by the principles of Poincaré plots, but transformed to resemble a circle rather than an ellipse. The Plot is built-up dynamically: each new beat appears immediately and older beats gradually fade away. The figure develops counter clock-wise, in this example spiraling outwards. Resonant breathing (see Section 4) is one of the ways to make the figure grow and spiral outward.

we rotated the plot over 45 degrees and changed the scaling of the axes so that a typical plot on average resembles a circle rather than an ellipse. For the formal details we refer to Appendix A. The screenshot of a plot thus made during a feedback session in our bio-feedback laboratory at TU/e is shown in Fig. 10.

It usually is a pleasurable experience to watch the heart beats go round. In fact, the beats tend not to be evenly distributed around a circle, but form clusters on one side, or even make a smaller orbit at a recurring position (this is visible in Fig. 10). The figure formed is sensitive: a worrying thought which pops up changes the pattern of beats immediately.

It is important to realize that, for each type of structural design decision, the surface-level representation still leaves a considerable degree of freedom for the designer to choose. For all three feedback types, the styling, for example, is still free. It must be said however that the calculated heart rate variability is easier to embed in a narrative (which is particularly interesting when the approach has to be based on an external motivation). It is easy to invent a story why the bird must fly higher, the fish swim deeper, the feather float upward, etc. To illustrate the claim that also for the circle plot there is still designer freedom left, we show a flower-style design in Fig. 11, based on the same heart beats as Fig. 10. The representation should be intuitive, meaning that a the opening of a flower, automatically drives the user in the right direction. One may wonder whether the aim of opening the spiral in Fig. 10 (representing more relation and so a higher HRV) is the most intuitive direction; vanishing the spiral into a vortex may be more self-explaining. More possibilities will be discussed in Section 7.

	outlier robustness	information richness	narrative adaptability
calculated heart rate variability	high	Low	high
successive beat-to-beat intervals	medium	Medium	medium
circle plot	low	High	low

Table. I. Strong and weak points of the three fundamentally different feedback types. High outlier robustness means that the user is not easily distracted or disturbed when an irregular heart beat occurs or when the sensor misses one or two beats. High information richness means that the user gets fast feedback on each beat rather than some slowly moving average. High narrative adaptability means that it is easy for the designer to deploy the feedback inside an arbitrary narrative, or game-like context.



Fig. 11. Circle plot obtained by the principles of Poincaré plots and styled using flowers. It would also be possible to generate one dynamic flower, each leaf representing one beat. These are just examples, the point being to illustrate that structural design decisions, and the surface-level representation can be chosen (almost) independently.

So now we have three structural designs for feedback, viz. (1) Representation of calculated HRV, (2) Representation of successive beat-to-beat intervals and (3) Circle plot (modified Poincaré plot). We compare them in Table I where we have qualified the options by our best understanding. Whether the qualifications are perceived similarly by all users, should be determined by further experiments.

It is also possible to combine several approaches three or even present all three types of information to the user. The resulting feedback loop then becomes like a PID controller (proportional-integrating-differentiating – often used for mechanic feedback control systems). The calculated HRV, with its accumulative effect is like the I (integrated signal). The representation of successive beat-to-beat intervals is like the P (proportional, direct and untransformed signal). The representation by the circle plots is like the D (the differential of successive signals).

During the forty-three heart beats shown in Fig 12, the Heart Rate Variability is gradually increasing. The bar plots are built-up from left to right. The upper bar plot is moving upward (meaning more Heart Rate Variability). The lower bar plot is showing larger waves (the longer the bar, the longer the beat-to-beat interval). The circle plot is built-up in a counter-clockwise fashion, one dot per heart beat. The circle plot is spiraling outward and thus shows the same gradual increase in Heart Rate Variability.

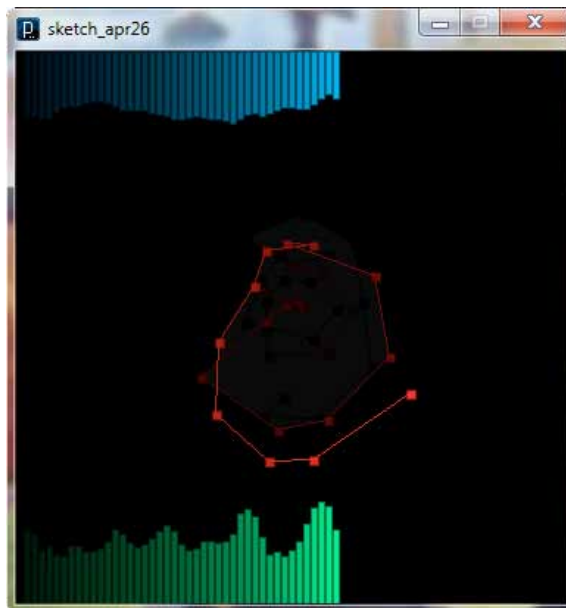

Fig. 12. Snapshot of one screen providing all three fundamentally different feedback types. The upper bar plot represents averaged Heart Rate Variability. The lower bar plot represents beat-to-beat intervals. The circle plot is obtained by the principles of Poincaré plots. It goes round, once per breath, showing one dot per heart beat.

7 Context of use

All design decisions should take the context of use into account. In the old meditation traditions such as mindfulness of the in and out breathing, the general advice is to find a quiet place. In the Buddha's words (MN118) [15]: "Here a monk gone to the forest or to the root of a tree or to an empty hut, sits down; having folded his legs crosswise, set his body erect, and established mindfulness in front of him, ever mindful he breathes in, mindful he breathes out." Contemporary Kabatt Zinn also points out how mindfulness can be practiced anywhere and anytime, summarized by the phrase "Wherever You Go There You Are". But the training of heart rate variability is more specific than a general present-moment-awareness. It demands awareness of the feedback information. Common sense tells that a quiet place will be helpful (it would be interesting to do experiments to see whether this assumption can be confirmed). It is the first author's personal experience that biofeedback given via a general-purpose computer brings the extra stress and frustration that usually come with computer-usage such as peripheral installation problems and associations with tasks such as email handling (in other words, using a computer to me *means* being very busy). By this consideration, a dedicated device is preferred. To design a dedicated room for meditation or relaxation can be done using objects and images of aesthetic quality and loaded with pointers to nature and meditation traditions (this is what we did for the biofeedback



Fig. 13. Biofeedback laboratory at TU/e. In fact the design and organization of the room is a compromise because of budget limitations and the need to include additional equipment for experiments.

laboratory at TU/e). On the other hand, if people could withdraw in a nice place for significant amounts of time, explicit techniques and biofeedback would perhaps not be needed at all. A portable device (cf. stress eraser) has the huge advantage that it can be deployed anywhere. A portable device offers, even for the user with a busy lifestyle, opportunities to pick the best possible (though not perfect) place and time to do the exercises. Each of the techniques of Table 1 can be mapped to either a computer or to a dedicated device or to an ambient installation (also see the next section).

8 Outlook

From the above examples one might guess that the research presented is only about 2D screen-based presentation, but actually it is not. It is well possible to present calculated HRV using an ambient installation or dynamic 3D object. A typical example would be a Buddha statue which would float higher when the HRV is higher (like the SOH19 States of Nature art work by Alex Vermeulen, but perhaps smaller, and driven by HRV, not solar intensity). Since calculated HRV changes only slowly, the technical problems are modest and even slow actuators can be deployed. Another example would be a lamp which gives less light or moves up towards the ceiling when HRV increases. For successive beat-to-beat intervals the same is possible, and the effect of high HRV would be that the object would engage in a kind of waving movement, following the user's breath. Clearly this puts extra

demands to the mechanism for the movement, which needs to be aesthetic and also fairly fast (at least one movement per second). For circle plots (modified Poincaré plots) it is also possible to present them in 3D space by a moving object, but now there have to be movements in two dimensions (perhaps like the lamps developed by Philip Ross and Philip Mendels [12] or the robots proposed by Alers [13]. For now we leave these as options to be explored.

Acknowledgments

We thank Kees Blase, Tom Djajadiningrat, Pierre Cluitmans and Loy Rovers for inspiring discussions on the interplay of design and bio-feedback.

References

- 1 Feijs, L. Rovers, L. & Cluitmans, P. (2009). Flanker shooting game; model-based design of biofeedback games. In A. Guénand (Ed.), Proceedings of DPPI09. (pp. 483-494). Université de Technologie de Compiègne.
- 2 Tarvainen M. & Niskanen JP. Kubios HRV Analysis. Version 2.0 beta. User's guide. Department of Physics. University of Kuopio. http://bsamig.uku.fi/kubios/kubios_hrv_users_guide.pdf (2.4.2008)
- 3 DeBoer RW, Karemaker JM & Strackee J. Hemodynamic fluctuations and baroreflex sensitivity in humans: a beat-to-beat model. *Am J Physiol Heart Circ Physiol* 253: H680–H689, 1987.
- 4 Thich Nhat Hanh. Breathe, You are alive! Sutra on the full awareness of breathing. ISBN: 978-1-888375-84-8, Revised Edition. Parallax Press, Berkely CA.
- 5 Bird, J. & Pinch, Ch (2002). Autogenic therapy - Self-help for mind and body. Newleaf (Gill & Macmillan). ISBN 978-0717134229.
- 6 Lehrer PM, Vaschillo E, Vaschillo B, Lu SE, Scardella A, Siddique M. & Habib RH. Biofeedback treatment for asthma. *Chest* (2004) 126(2) 352-361.
- 7 Hasset, AL, Radvanski DC, Vaschillo EG, Vaschillo B, Sigal LH, Karavidas MK, Buyske S & Lehrer PM (2007). A pilot study of the efficacy of heart rate variability (HRV) biofeedback in patients with fibromyalgia. *Applied Psychophysiology and Biofeedback* 32(1) 1-10.
- 8 Karavids, MK, Lehrer PM, Vaschillo E, Vaschillo B, Marin H, Buyske S, Malinovsky I, Radvanski D & Hasset A (2007). Preliminary results of an open label study of heart rate variability biofeedback for the treatment of major depression. *Applied Psychophysiology and Biofeedback*. 32(1) 19-30.
- 9 Zucker TL, Samuelson, KW, Muench F, Greenberg MA & Gevirtz RN (2009). The effects of respiratory sinus arrhythmia biofeedback on heart rate variability and post traumatic stress disorder symptoms: a pilot study. *Applied Psychophysiology and Biofeedback*. 34(2) 135-43.
- 10 Aart, J. van, Klaver, E.R.G., Bartneck, C., Feijs, L.M.G. & Peters, P.J.F. (2008). EEG headset for neurofeedback therapy : enabling easy use in the home environment. Proceedings of the Biosignals 2008 : International Conference on Bio-inspired Signals and Systems, Funchal, Madeira (Vol. 2, pp. 23-30). Los Alamitos: IEEE.
- 11 Malliani, A, Lombardi, F & Pagani, M (1994). Power spectrum analysis of heart rate variability: a tool to explore neural regulatory mechanisms, *Br Heart J*. 1994 January; 71(1): 1–2.
- 12 Djajadiningrat, J.P., Geurts, L., Munniksmas, P.R., Christiaansen, G., & De Bont, J. (2009). Rationalizer: An emotion mirror for online traders. Proceedings of DeSForM, Taipei, 39-48.
- 13 Processing open source programming language and environment, <http://processing.org/>
- 14 Brennan, M. Palaniswami & M. Kamen, P. (2001). Do existing measures of Poincare plot geometry reflect nonlinear features of heart rate variability? *IEEE Transactions on Biomedical Engineering*, Volume 48, Issue 11, Nov. 2001, pp. 1342 – 1347.
- 15 Nanamoli, B & Bodhi, B (Translators) (1995). The Middle Length Discourses of the Buddha, A Translation of the Majjhima Nikaya, Wisdom Publication, Somerville, MA.
- 16 Ross, Ph. (2008) Ethics and aesthetics in intelligent product and system design. Ph.D. thesis, TU/e
- 17 Alers, S.H.M. & Hu, J. (2009). AdMoVeo: a robotic platform for teaching creative programming to designers. Learning by playing. Game-based education system design and development. (pp. 410-421) Springer Berlin/Heidelberg.

Appendix: Calculations

In this appendix we give the formulas for calculating the coordinates of the circle plot as used in our prototype software. Our prototype software is written in Processing, but the equations and assignments are easily deployed in any language of the reader's choice. These are the main equations:

$$\begin{aligned}
 x &= (RR - RR_{avg}) / 3 \\
 y &= -(RR_{prev} - RR_{avg}) / 3 \\
 x_{rot} &= (7*x)/10 + (7*y)/10 \\
 y_{rot} &= -(7*x)/10 + (7*y)/10 \\
 x_{plot} &= 2*x_{rot} + width/2 \\
 y_{plot} &= y_{rot} + height/2
 \end{aligned}$$

In these equations RR refers to the last measured beat-to-beat interval. The notation RR stems from Willem Einthoven who described the various ECG elements, such as the QRS complex, in which R denotes the main peak in the ECG. Thus RR is the difference between two successive R peaks, that is, the beat-to-beat interval. We use the same notation also when the signal is derived with a PPG sensor, although formally it is not the same since pulse transmission times could play a role. RR_{avg} denotes the average value of RR. RR_{prev} denotes the previous value of RR. The first and the second equation make the initial x and y values relative to the average and perform a practical scaling. The third and fourth equation rotate the x and y values over 45 degrees. The value of 7/10 is used as an approximation of the sine of 45 degrees, so simple integer arithmetic suffices (more accurate would be 0.707107). The fifth and the sixth equation maneuver the results towards the center of the screen. At the same time the plot is horizontally stretched by a factor of two, turning a typical ellipse-like plot into something more like a circle. The notations width and height refer to the dimensions of the screen used (this is also the notation used inside the Processing programming environment). And the purpose of all this is of course to finally use the resulting x_{plot} and y_{plot} as coordinates. Finally we give two assignments to be executed after each beat.

```
RR_prev □ RR
RR_avg □ (23 * RR_avg + RR)/24
```

The notation □ denotes assignment (write = in program code). The first assignment serves to update the value of RR_{prev} before RR will be overwritten by the new beat. The second assignment calculates a weighted average over the RR intervals, giving higher weight to the later intervals, and gradually fading out the impact of intervals long ago. The time constant of this averaging process is 24 beats.

Loe M.G. Feijs
Geert Langereis
 Eindhoven University
 of Technology,
 Department of
 Industrial Design,
 Eindhoven,
 the Netherlands
Geert van Boxtel
 Tilburg University,
 Faculty of Social
 and Behavioural
 Sciences, Tilburg,
 the Netherlands